

asa
alumínio

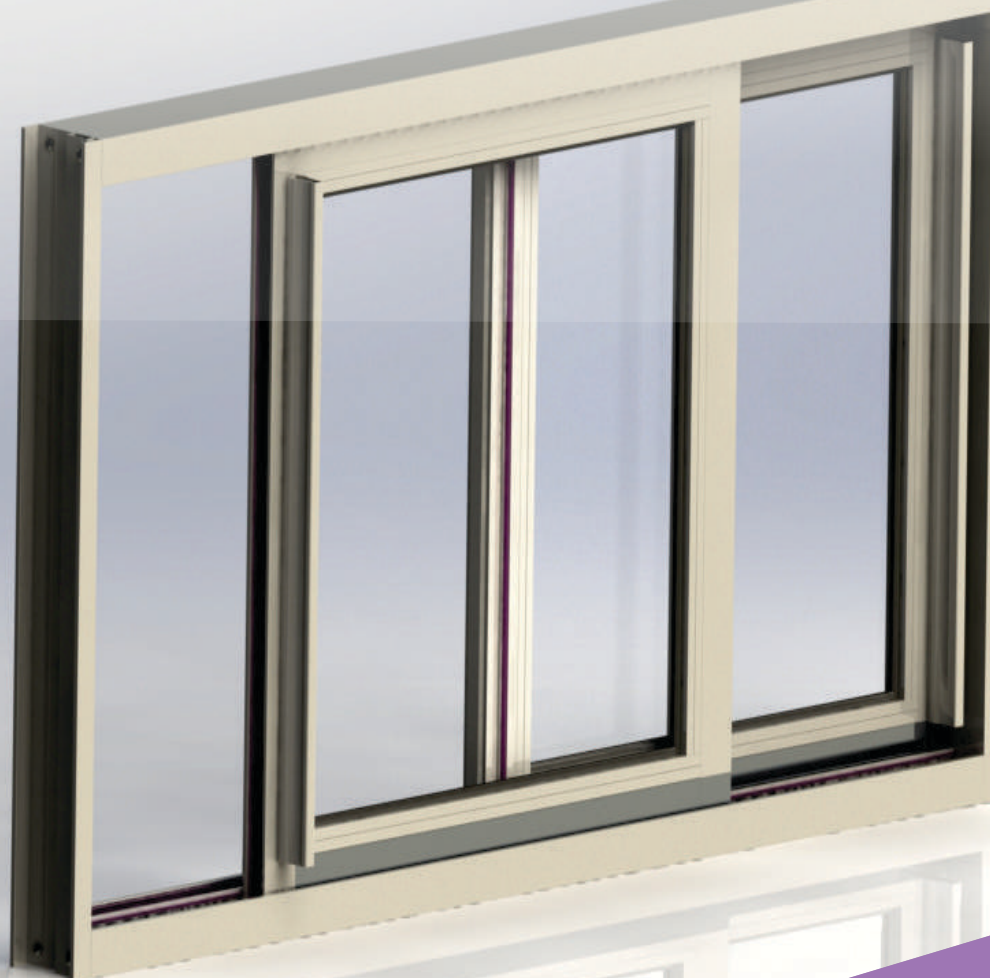

MegaCountry

SÉRIE MODULAR (LINHA 16 PADRONIZADA)

MegaVillage

LINHA 20 SEM CONTRAMARCO (SERIADA)





! IMPORTANTE:

A utilização de perfis de alumínio para aplicação em Esquadrias, fabricação de Janelas, Portas, Fachadas Pele de Vidro ou Glazing, Gradis, Guarda-Corpos, Box e demais produtos possíveis com os perfis e complementos, mesmo que não estejam contidos neste catálogo, requer conhecimento técnico adequado de profissionais experientes com conhecimento das normas técnicas brasileiras e domínio do processo de industrialização e instalação.

A Asa Alumínio S.A. não se responsabiliza pelo resultado dos trabalhos com perfis por ela comercializados, nem pelo uso inadequado, imperícia e ou inabilidade da aplicação.

asa
alumínio



ASA ALUMÍNIO

19 3227-1000 | Rua da Cerâmica, 100 São José
19 3727-2000 | 13051-156 Campinas - SP

A Asa Alumínio é uma empresa atuante, em franca expansão e presente nos principais mercados do país. Com duas unidades industriais, a empresa está equipada com cinco prensas de alta performance e preparada para atender os mais altos níveis de qualidade, precisão dimensional e rigorosa exigência de perfis complexos e de grandes dimensões.

Toda uma estrutura técnica e comercial está à disposição para dar suporte, orientação e apoio para o desenvolvimento de sistemas construtivos para todas as aplicações da Construção Civil e Componentes Industriais.

FABRICAÇÃO E MANUSEIO

A operação com perfis de alumínio para fabricação de esquadrias, incluindo portas, janelas, requer mão-de-obra com conhecimento comprovado e vivência no setor, e o manuseio dos perfis deve ser feito em local apropriado com equipamentos adequados.

PADRÕES E NORMAS

As Esquadrias de Alumínio precisam atender as especificações das Normas Brasileiras (ABNT), especialmente previstas na NBR 10.821 e NBR 15.575 (no caso de Portas e Janelas). Demais componentes como Vidro, Acessórios, Guarnições, Vedantes, Parafusos, Rebites e Tratamento de Superfície também devem obedecer respectivas normas.

MegaCountry MegaVillage

São dois conjuntos de perfis que compõem o Sistema Construtivo Mega para esquadrias seriadas. A Linha Mega Modular (Mega 16 Country) e a Linha Mega 20 Village, ambas completas em possibilidades de tipologias, incluindo opções com GRADE. Perfis reconfigurados para atender a estética da arquitetura moderna e design de conjunto projetado para assegurar a performance estrutural exigida pelas Normas Brasileiras.

As duas Linhas, Mega 16 Country e Mega 20 Village, podem ser usadas de forma complementar (juntas) multiplicando a riqueza na variedade de combinações que favorecem o vasto portfólio de tipologias e que resulta em um excelente ganho na produção das peças.

Perfis exclusivos para indústrias de Portas e Janelas seriadas (padronizadas) com Certificação de Qualidade Asa Alumínio.

Lined area for notes.

PERFIS *MegaCountry*

PERFIL	PESO	PÁG.	PERFIL	PESO	PÁG.
MG16-305	0,154	10	MG16-315	0,191	10
MG 16-140	0,312	8	MG16-320	0,101	10
MG16-120	0,279	8	MG16-325	0,112	10
MG16-100	0,387	7	MG16-330	0,176	10
MG16-110	0,471	7	MG16-335	0,171	10
MG16-115	0,500	7	MG16-340	0,172	10
MG16-125	0,259	8	MG16-345	0,172	10
MG16-130	0,259	8	MG16-350	0,097	10
MG16-135	0,332	8	MG16-355	0,112	10
MG16-145	0,344	8	MG16-365	0,107	10
MG16-150	0,288	9	MG16-370	0,219	9
MG16-155	0,207	9	MG16-371	0,221	9
MG16-160	0,194	9	MG16-375	0,282	9
MG16-165	0,255	10	MG16-380	0,407	9
MG16-170	0,261	9	MG16-385	0,384	9
MG16-175	0,265	9	MG16-390	0,301	8
MG16-180	0,251	9	MG16-395	0,333	8
MG16-185	0,285	10	MG16-400	0,480	7
MG16-210	0,370	9	MG16-545	0,130	10
MG16-215	0,388	9	MG16-550	0,155	10
MG16-220	0,332	9	MG16-555	0,097	10
MG16-225	0,636	8	MG16-105	0,423	7
MG16-226	0,684	11	MG16-225	0,639	11
MG16-230	0,799	12			
MG16-231	0,908	12			
MG16-265	0,440	7			
MG16-288	0,320	11			
MG16-310	0,112	10			

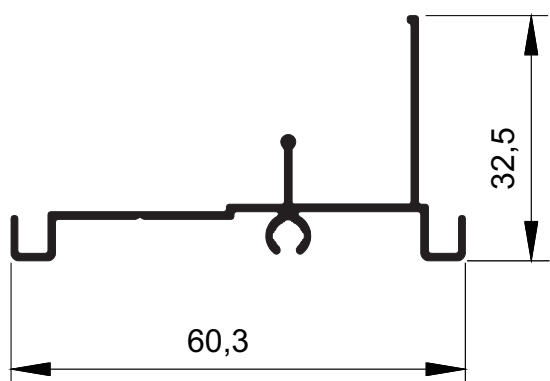

MG16-100

0,387 kg/m

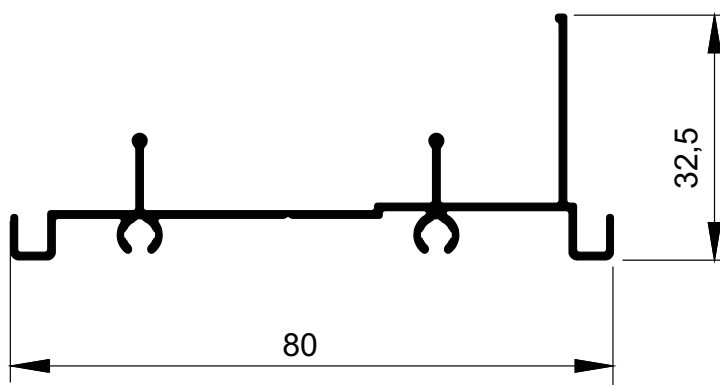

MG16-110

0,471 kg/m

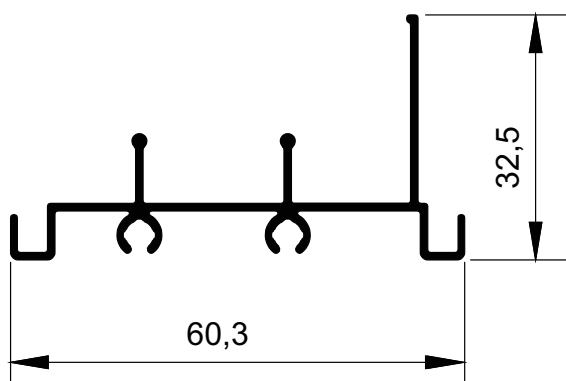

MG16-105

0,423 kg/m

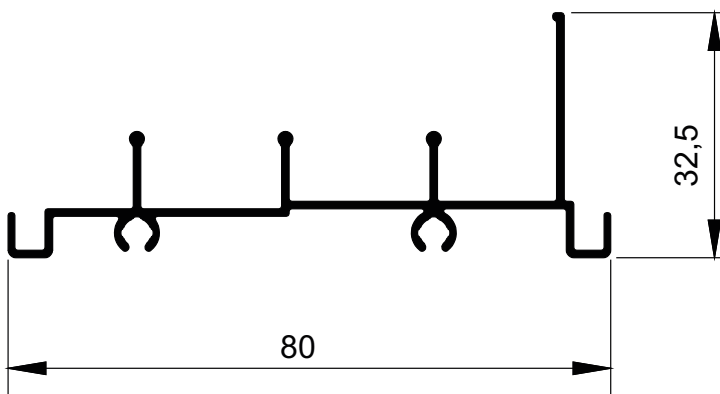

MG16-115

0,500 kg/m

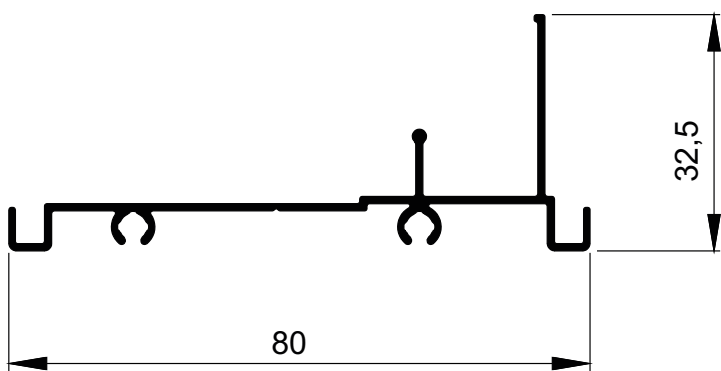

MG16-265

0,400 kg/m

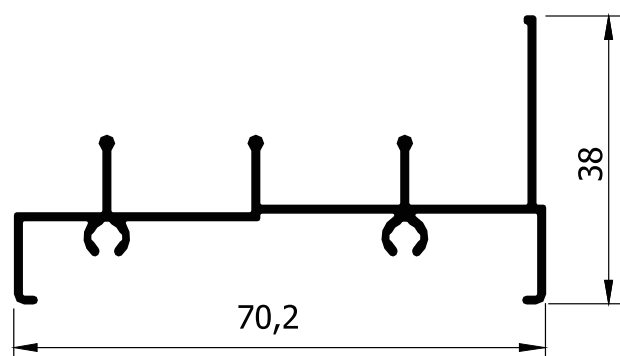

MG16-400

0,490 kg/m

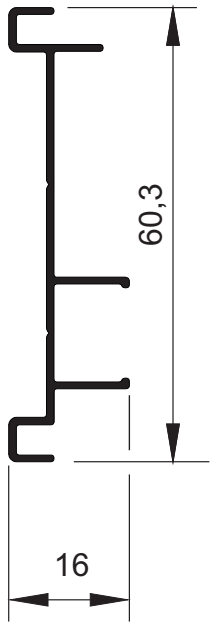

MG16-120
0,279 kg/m

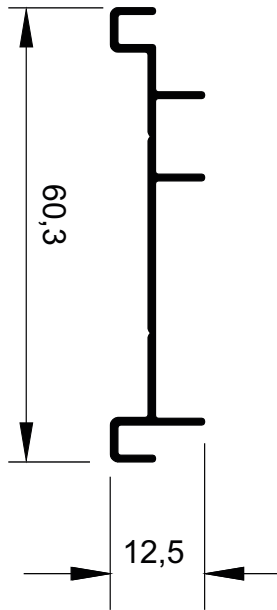

MG16-125
0,259 kg/m

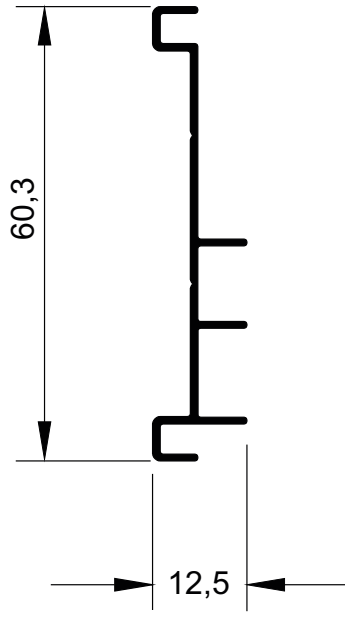

MG16-130
0,259 kg/m

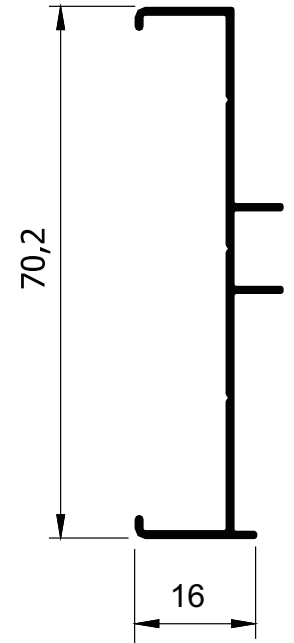

MG16-390
0,301 kg/m

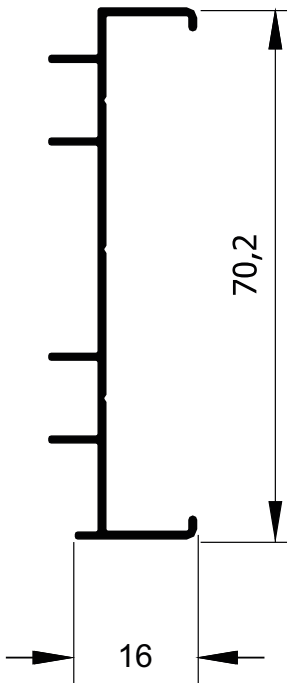

MG16-395
0,333 kg/m

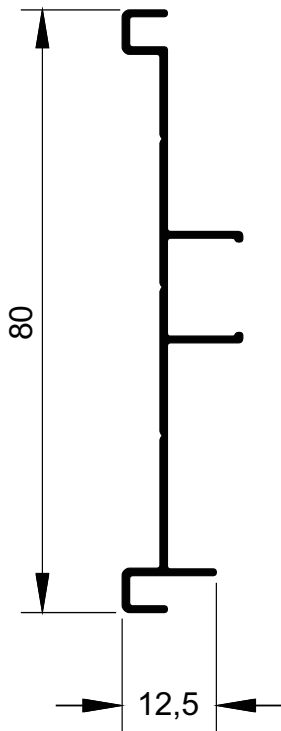

MG16-135
0,332 kg/m

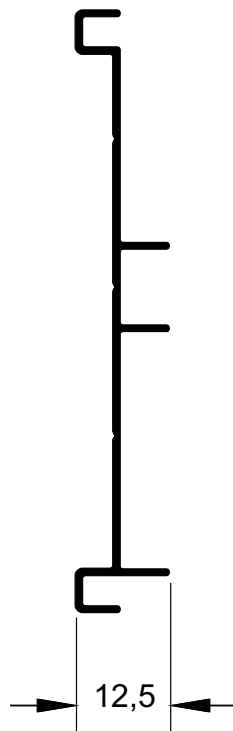

MG16-140
0,312 kg/m

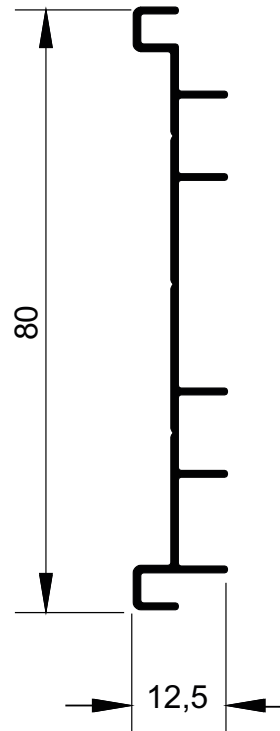

MG16-145
0,344 kg/m

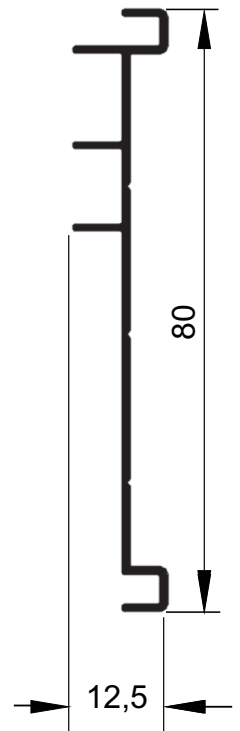

MG16-288
0,320 kg/m

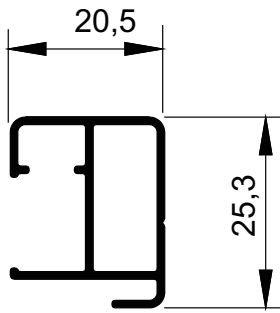

MG16-150
0,266 kg/m

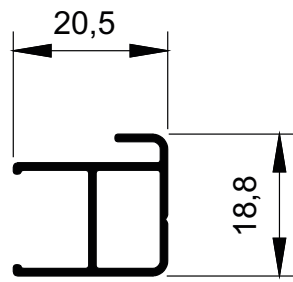

MG16-155
0,207 kg/m

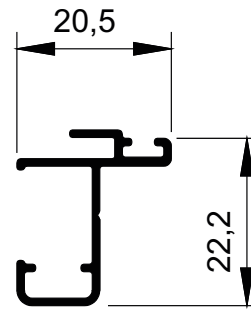

MG16-160
0,194 kg/m

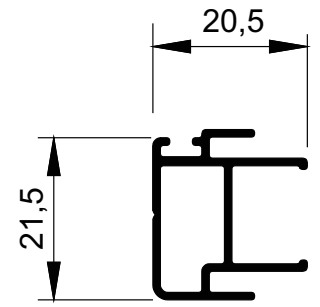

MG16-170
0,261 kg/m

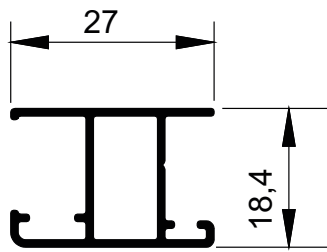

MG16-175
0,265 kg/m

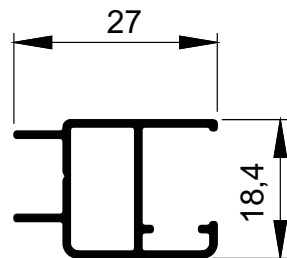

MG16-180
0,251 kg/m

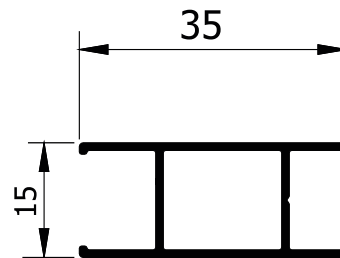

MG16-375
0,262 kg/m

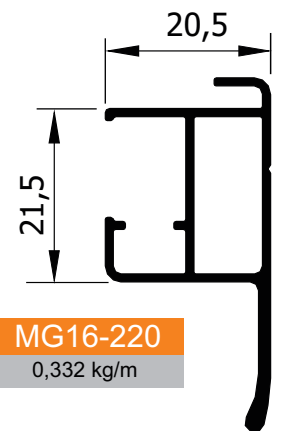

MG16-220
0,332 kg/m

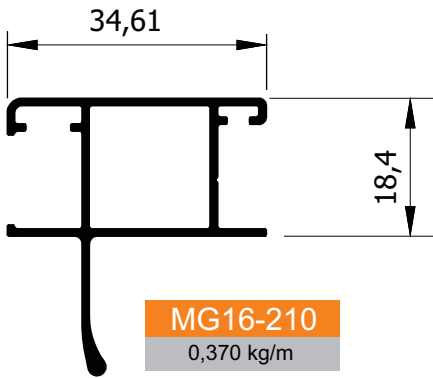

MG16-210
0,370 kg/m

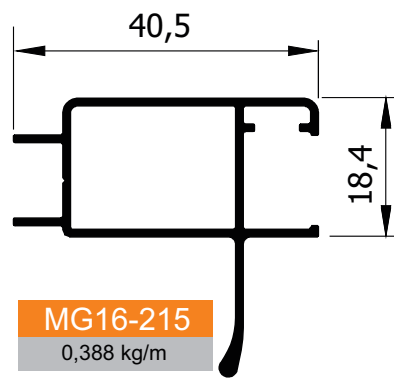

MG16-215
0,388 kg/m

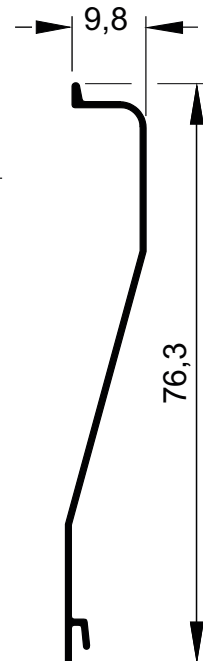

MG16-370
0,219 kg/m

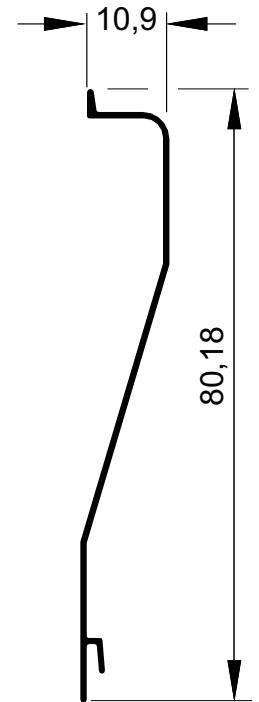

MG16-371
0,221 kg/m

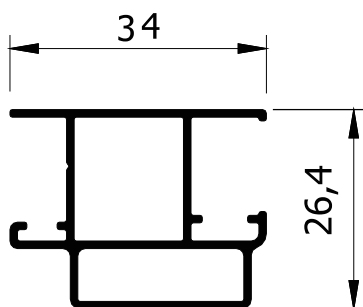

MG16-380
0,407kg/m

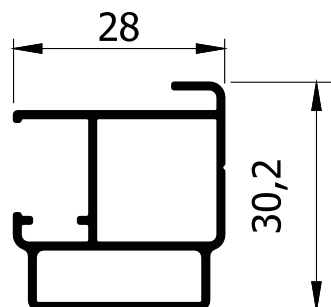

MG16-385
0,384 kg/m

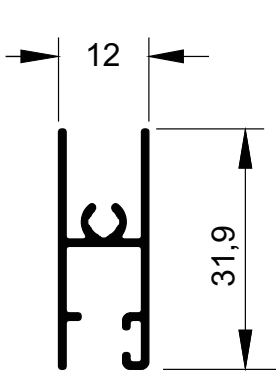

MG16-165
0,255 kg/m

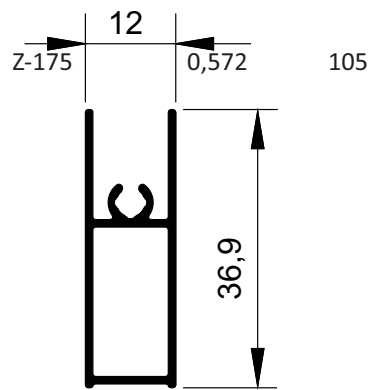

MG16-185
0,285 kg/m

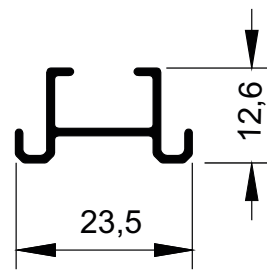

MG16-305
0,154 kg/m

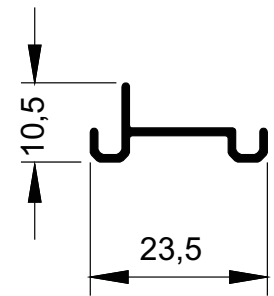

MG16-310
0,112 kg/m

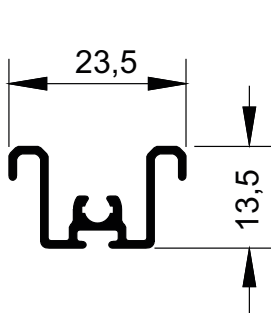

MG16-315
0,181 kg/m

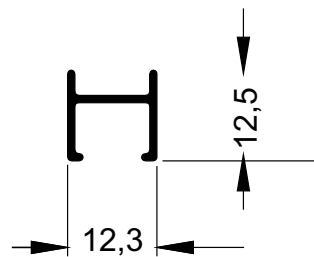

MG16-320
0,101 kg/m

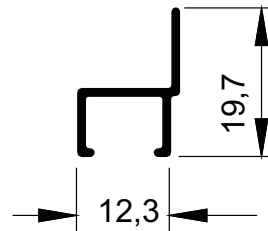

MG16-325
0,112 kg/m

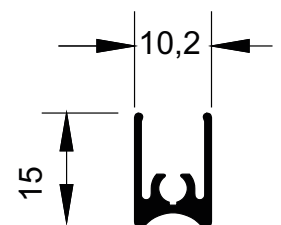

MG16-330
0,176 kg/m

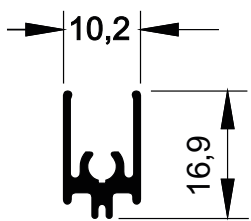

MG16-335
0,171 kg/m

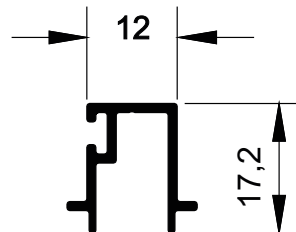

MG16-340
0,172 kg/m

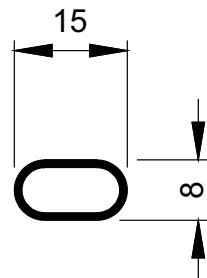

MG16-350
0,097 kg/m

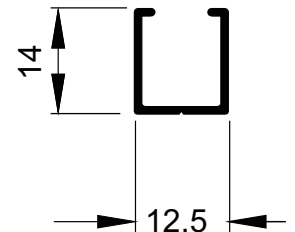

MG16-355
0,112 kg/m

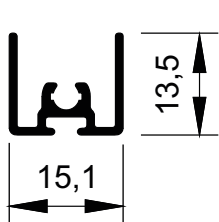

MG16-550
0,155 kg/m

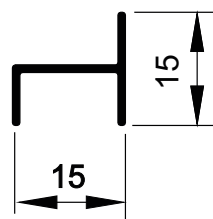

MG16-555
0,097 kg/m

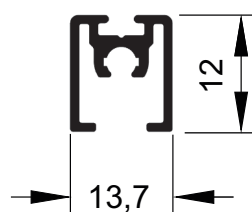

MG16-345
0,167 kg/m

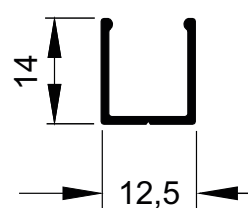

MG16-365
0,107 kg/m

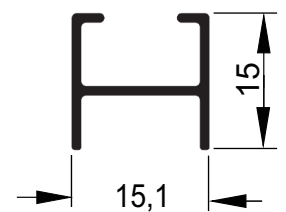

MG16-545
0,130 kg/m

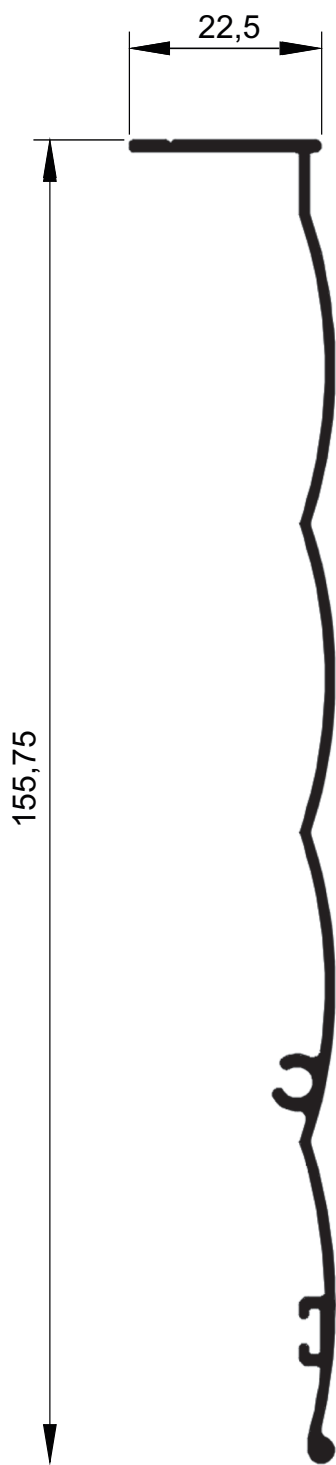

MG16-225
0,636 kg/m

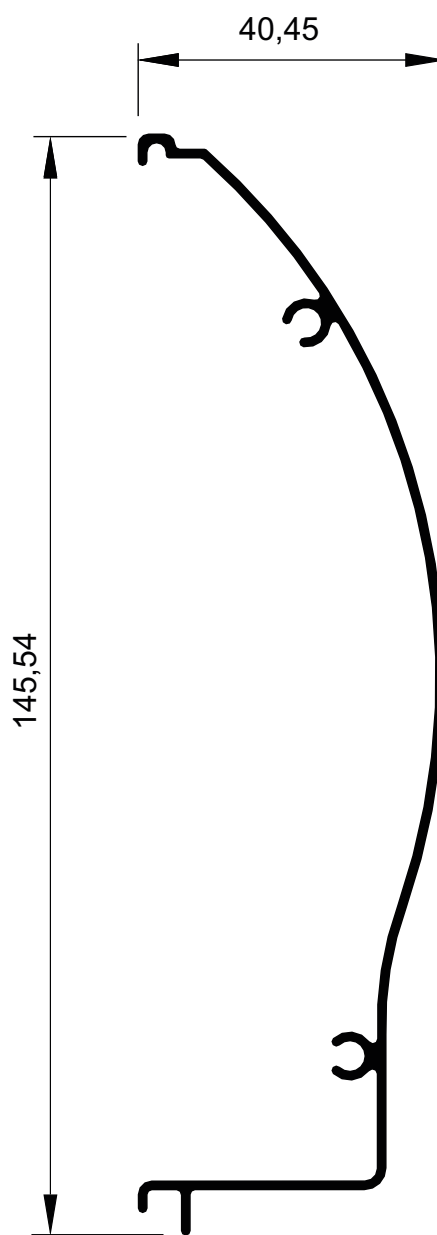

MG16-226
0,682 kg/m



MG16-230
0,796 kg/m

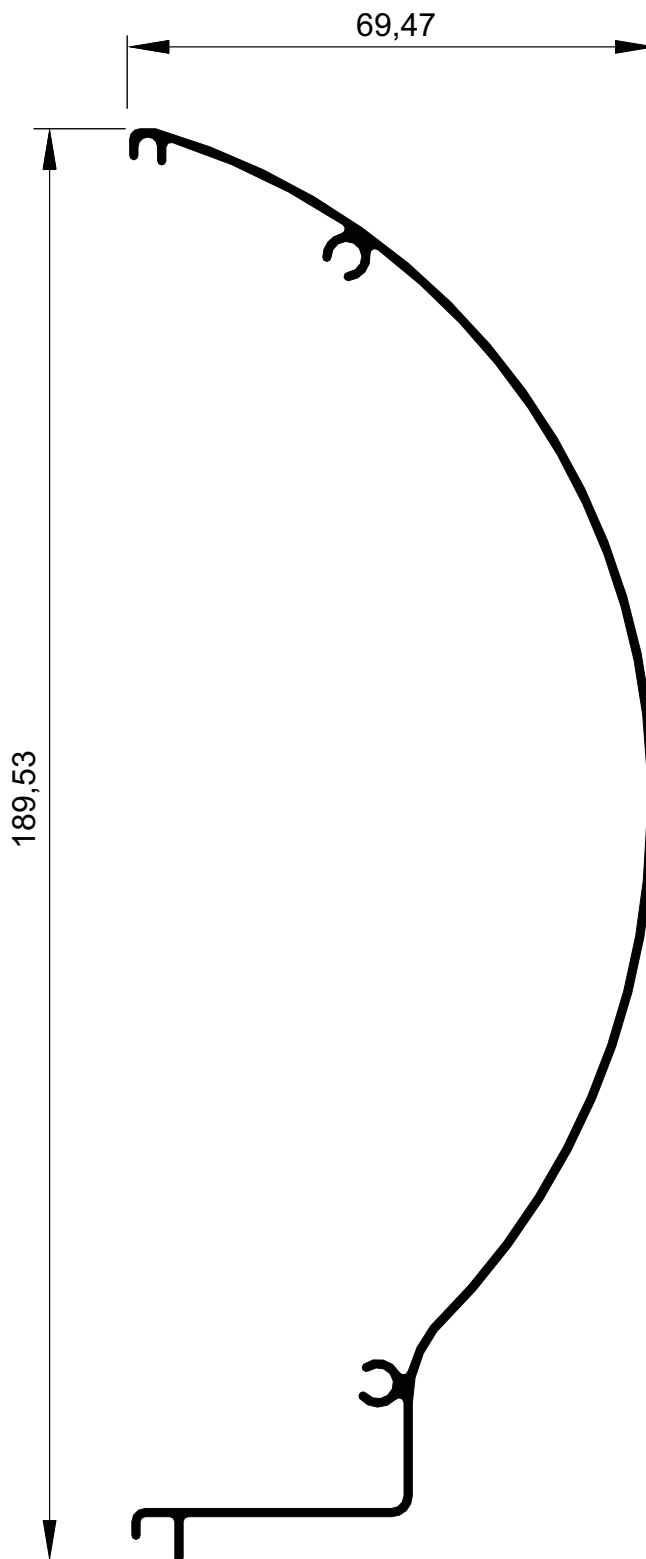

MG16-231
0,904 kg/m

TIPOLOGIAS POSSÍVEIS

JANELA DE CORRER 2 FOLHAS 1FX 1M SG VITRÔ

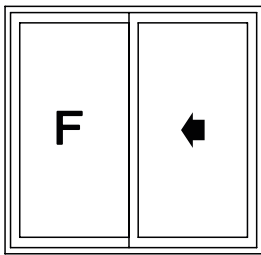

- MG16-100
- MG16-120
- MG16-130
- MG16-160
- MG16-175
- MG16-150
- MG16-155
- MG16-165
- MG16-185
- MG16-210
- MG16-220
- MG16-380
- MG16-385

JANELA DE CORRER 3 FOLHAS 1FX 2M SG VENEZIANA

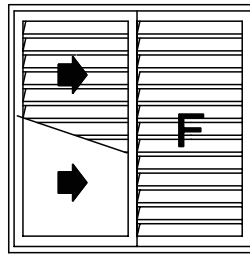

- MG16-110
- MG16-135
- MG16-145
- MG16-150
- MG16-155
- MG16-165
- MG16-170
- MG16-175
- MG16-185
- MG16-370
- MG16-210
- MG16-220
- MG16-385
- MG16-380

JANELA DE CORRER 2 FOLHAS 2M SG VITRÔ

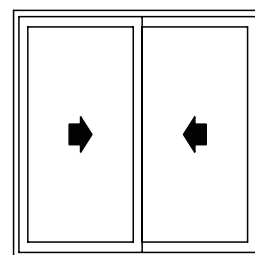

- MG16-105
- MG16-130
- MG16-125
- MG16-150
- MG16-155
- MG16-165
- MG16-175
- MG16-210
- MG16-220
- MG16-385
- MG16-380

JANELA DE CORRER 4 FOLHAS 2FX 2M SG VITRÔ

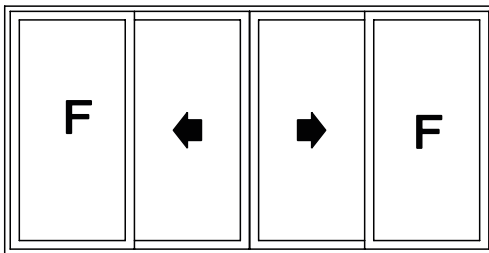

- MG16-100
- MG16-120
- MG16-150
- MG16-155
- MG16-160
- MG16-165
- MG16-175
- MG16-180
- MG16-185
- MG16-210
- MG16-220
- MG16-215

JANELA DE CORRER 3 FOLHAS 3M SG VENEZIANA

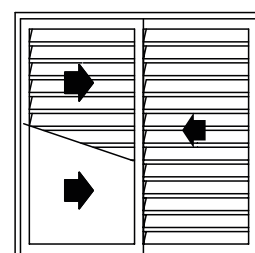

- MG16-390
- MG16-395
- MG16-400
- MG16-115
- MG16-140
- MG16-145
- MG16-150
- MG16-155
- MG16-165
- MG16-170
- MG16-175
- MG16-370
- MG16-210
- MG16-220
- MG16-385
- MG16-380
- MG16-375

JANELA DE CORRER 2 FOLHAS 1FX 1M CG VITRÔ

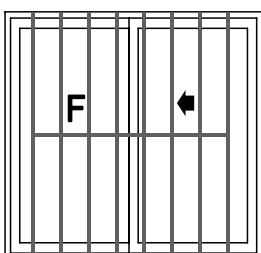

- MG16-265
- MG16-135
- MG16-288
- MG16-160
- MG16-150
- MG16-155
- MG16-165
- MG16-175
- MG16-185
- MG16-350
- MG16-355
- MG16-365
- MG16-210
- MG16-220
- MG16-385
- MG16-380

JANELA DE CORRER 6 FOLHAS 2FX 4M SG VENEZIANA

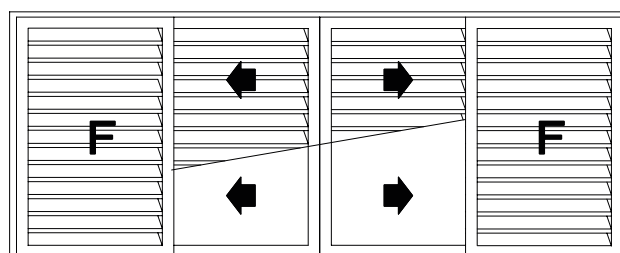

- MG16-110
- MG16-135
- MG16-150
- MG16-155
- MG16-165
- MG16-170
- MG16-175
- MG16-180
- MG16-185
- MG16-370
- MG16-215
- MG16-210
- MG16-220

JANELA DE CORRER 3 FOLHAS 1FX 2M CG
VENEZIANA

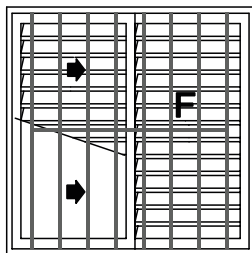

MG16-110
MG16-135
MG16-145
MG16-150
MG16-155
MG16-165
MG16-170
MG16-175
MG16-185
MG16-350
MG16-355
MG16-365
MG16-370

JANELA DE CORRER 4 FOLHAS 2FX 2M CG
VITRÔ

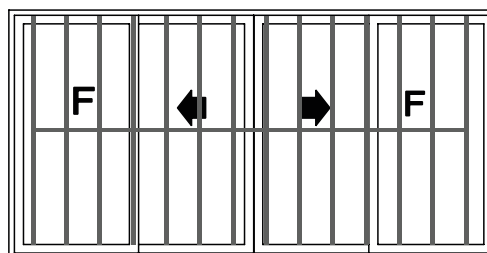

MG16-135
MG16-180
MG16-160
MG16-165
MG16-150
MG16-155
MG16-175
MG16-185
MG16-265
MG16-350
MG16-355
MG16-365
MG16-210
MG16-220
MG16-215

JANELA DE CORRER 6 FOLHAS 2FX 4M CG
VENEZIANA

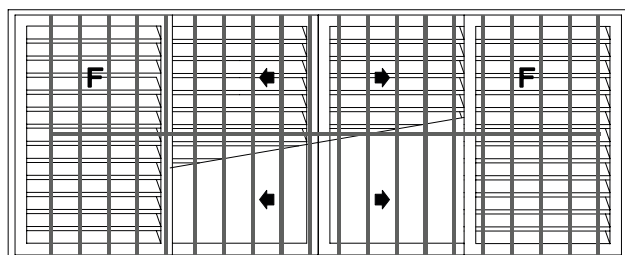

MG16-110
MG16-135
MG16-150
MG16-155
MG16-165
MG16-170
MG16-175
MG16-180
MG16-185
MG16-350
MG16-355
MG16-365
MG16-370

JANELA BASCULANTE PLACA

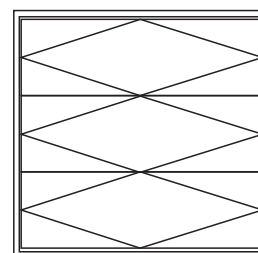

MG16-305
MG16-310
MG16-315
MG16-320
MG16-325
MG16-330
MG16-335

JANELA BASCULANTE (PLÁSTICO BOLHA)

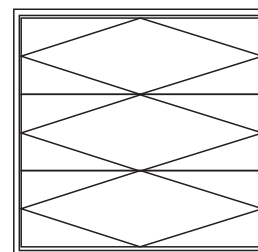

MG16-545
MG16-550
MG16-555
MG16-320
MG16-325
MG16-330
MG16-335

Large lined writing area with horizontal lines.

Mega[®] Village



A large rectangular area with rounded corners, containing horizontal lines for writing notes.



PERFIS *Mega Village*

PERFIL	PESO	PÁG.	PERFIL	PESO	PÁG.
39-933	0,179	30	MG20-1605	0,337	28
BG-035	0,119	27	MG20-1610	0,408	27
MG20-1000	0,631	23	MG20-1615	0,222	27
MG20-1005	0,541	23	MG20-1620	0,197	26
MG20-1010	0,828	24	MG20-1625	0,154	27
MG20-1015	0,765	24	MG20-1630	0,106	27
MG20-1020	0,530	23	MG20-2200	0,412	27
MG20-1025	0,451	23	MG20-2210	0,435	27
MG20-1030	0,650	25	MG20-2220	0,440	28
MG20-1035	0,659	24	MG20-2230	0,574	27
MG20-1037	0,548	24	MG20-2240	0,300	27
MG20-1040	0,408	26	MG20-2250	0,280	27
MG20-1045	0,467	26	MG25-301	0,343	28
MG20-1055	0,804	26	MG25-313	0,283	28
MG20-1060	0,835	26	MM-376	0,590	28
MG20-1065	0,669	26	RA-347	0,197	27
MG20-1070	0,437	26			
MG20-1075	0,563	26			
MG20-1081	0,508	23			
MG20-1086	0,544	23			
MG20-1090	0,662	26			
MG20-1105	0,779	25			
MG20-1110	0,849	25			
MG20-1120	0,548	25			
MG20-1140	0,904	24			
MG20-1145	0,841	25			
MG20-1150	0,674	23			
MG20-1155	0,603	23			

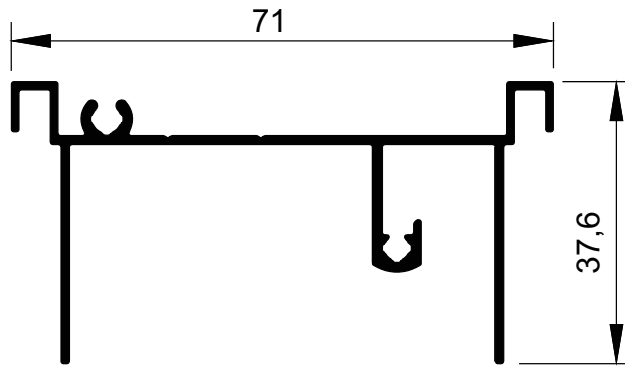

MG20-1000

0,631 kg/m

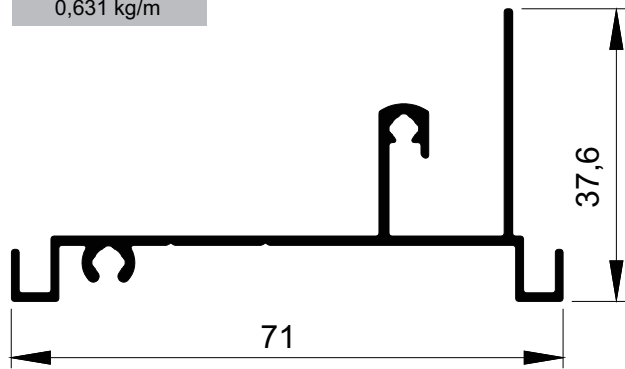

MG20-1005

0,541 kg/m

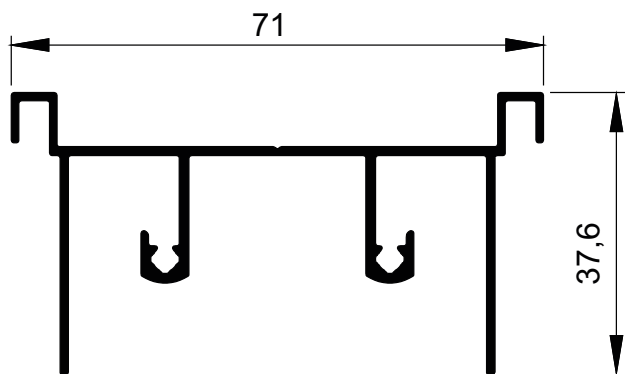

MG20-1050

0,674kg/m

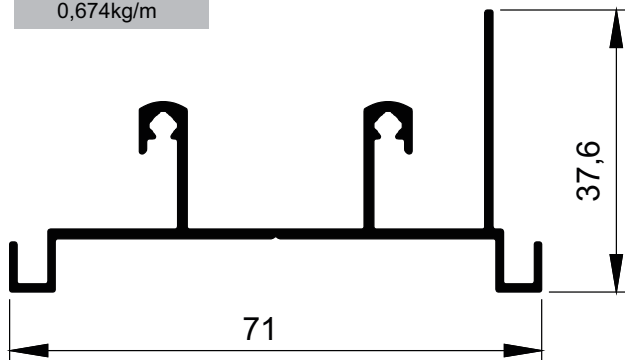

MG20-1155

0,603 kg/m

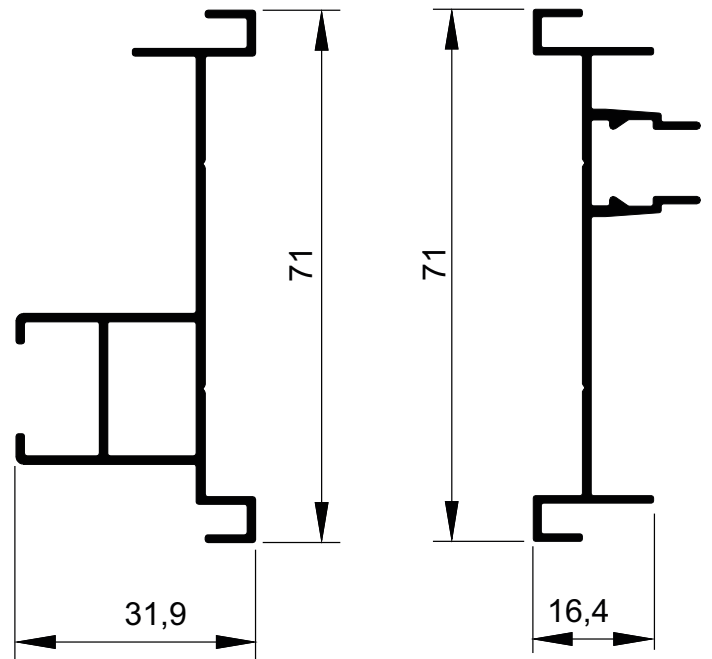

MG20-1020

0,530 kg/m

MG20-1025

0,451 kg/m

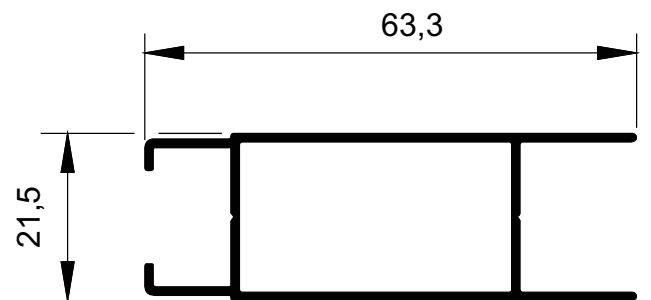

MG20-1081

0,508 kg/m

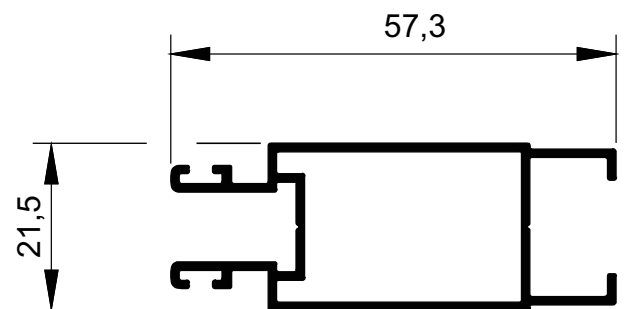

MG20-1086

0,544 kg/m

Lined area for notes.

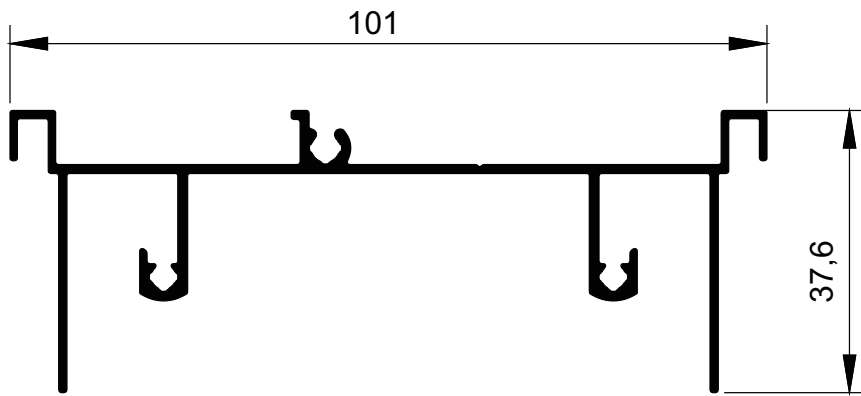

MG20-1010
0,828 kg/m

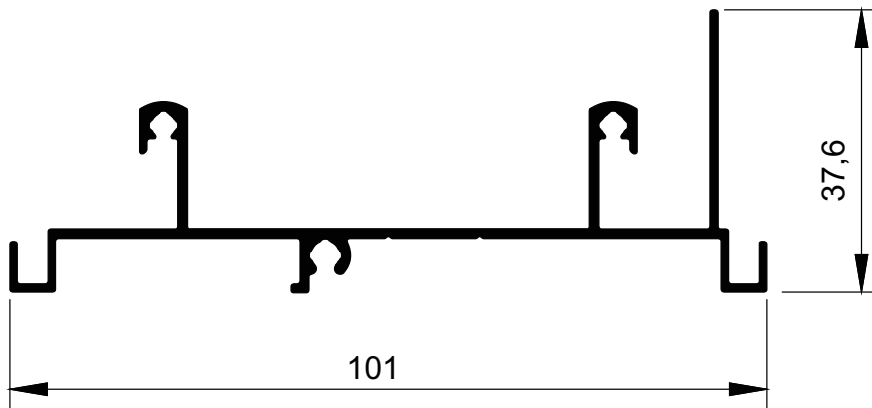

MG20-1015
0,765 kg/m

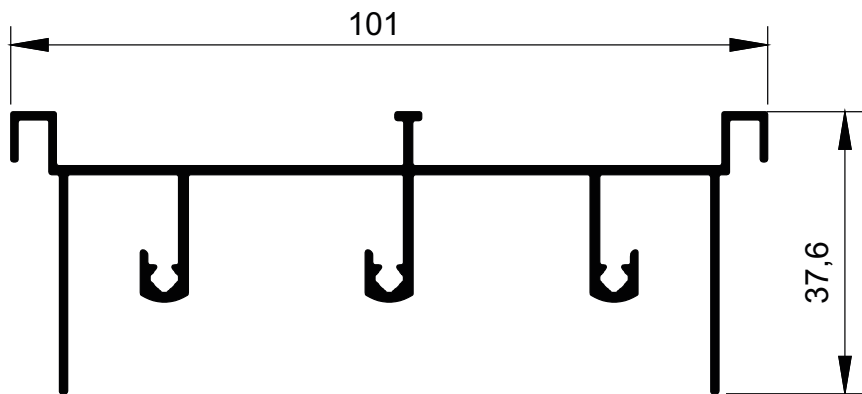

MG20-1140
0,904 kg/m

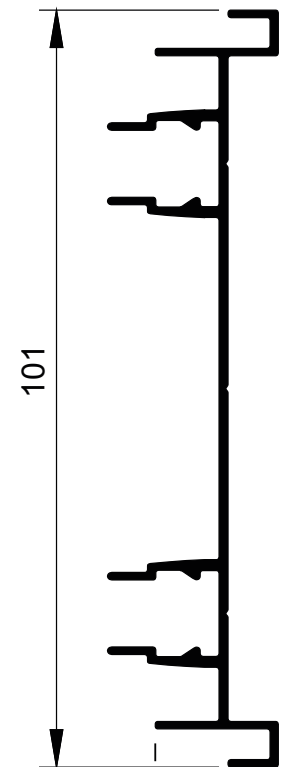

MG20-1035
0,659 kg/m

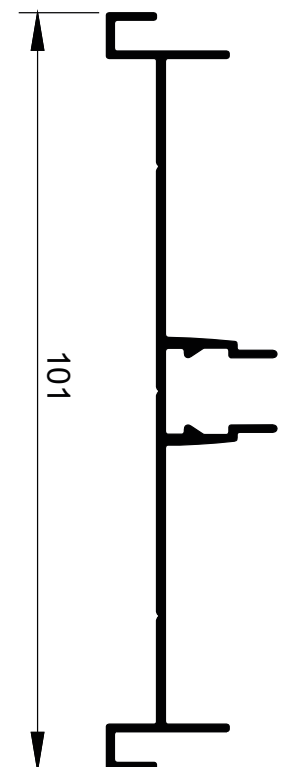

MG20-1037
0,548 kg/m

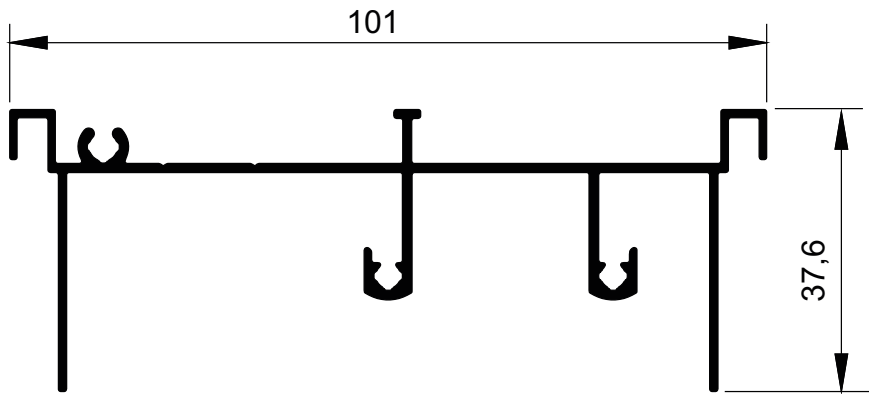

MG20-1110
0,849 kg/m

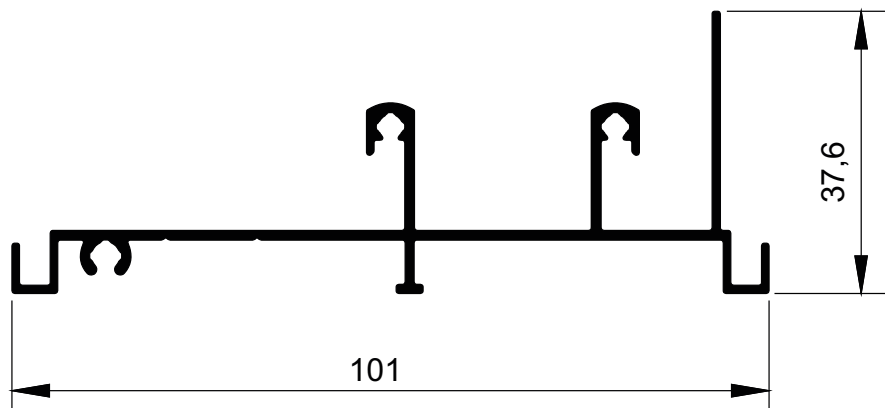

MG20-1105
0,779 kg/m

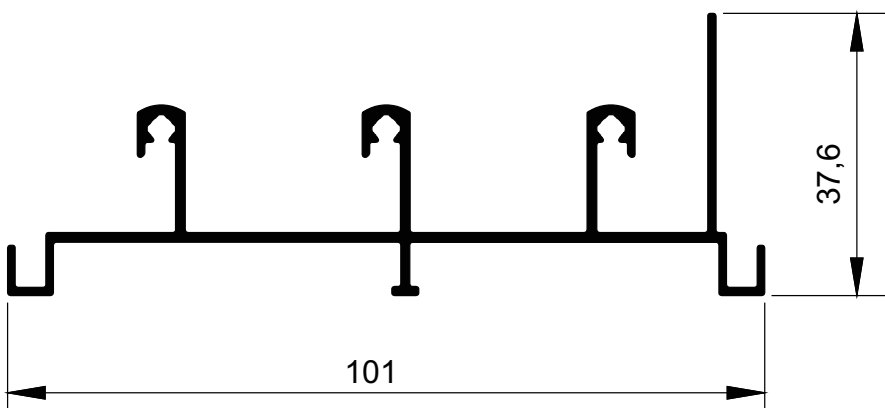

MG20-1145
0,841 kg/m

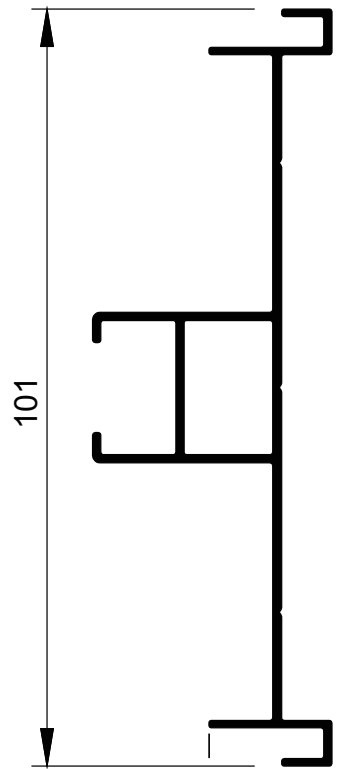

MG20-1030
0,650 kg/m

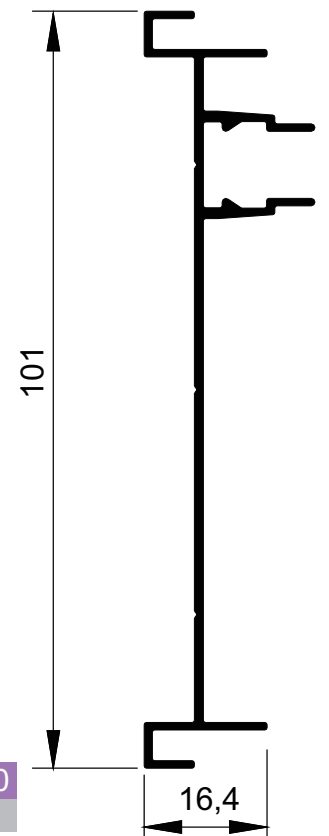

MG20-1120
0,548 kg/m

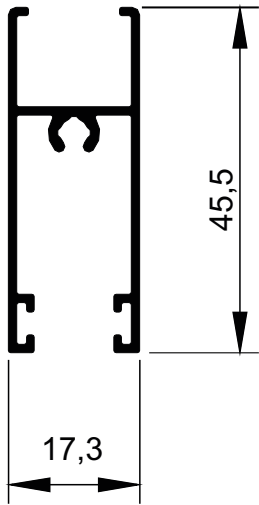

MG20-1040

0,408 kg/m

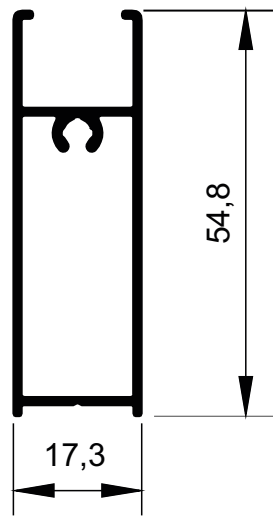

MG20-1045

0,467 kg/m

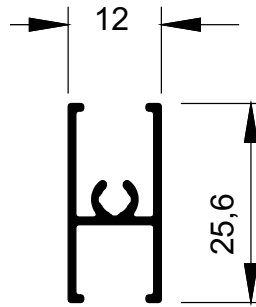

MG20-1620

0,197 kg/m

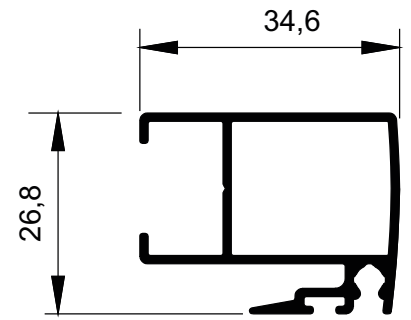

MG20-1070

0,437 kg/m

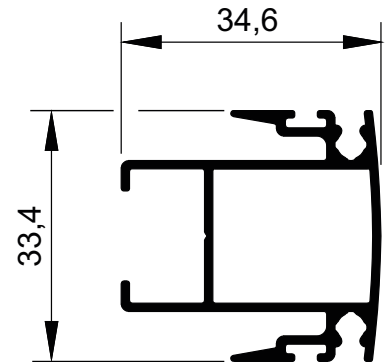

MG20-1075

0,563 kg/m

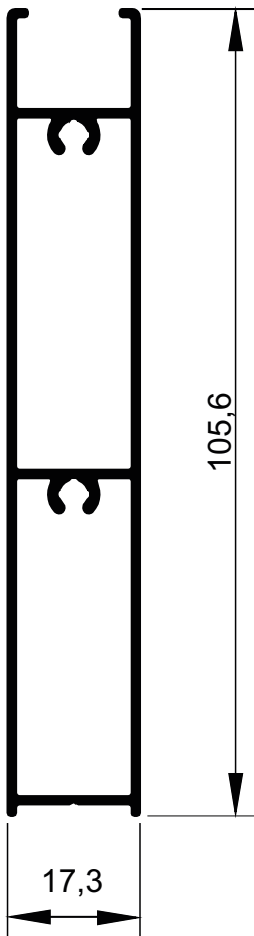

MG20-1060

0,855 kg/m

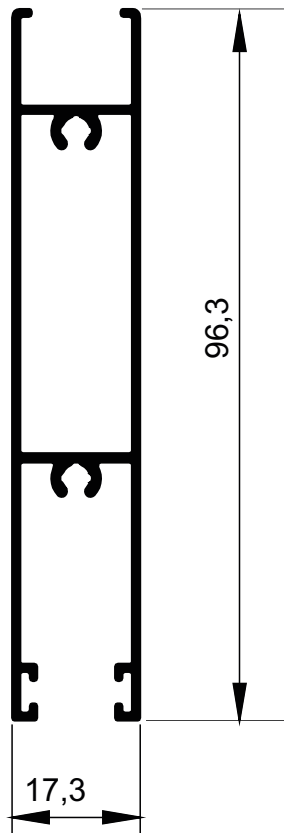

MG20-1055

0,804 kg/m

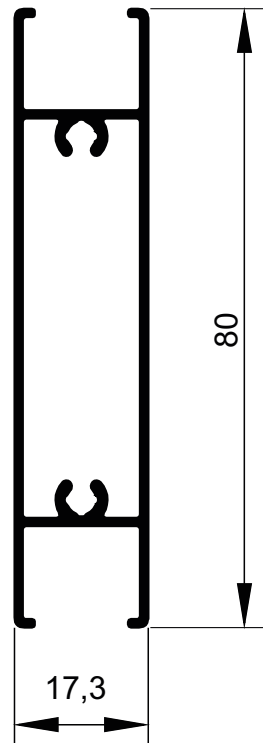

MG20-1065

0,669 kg/m

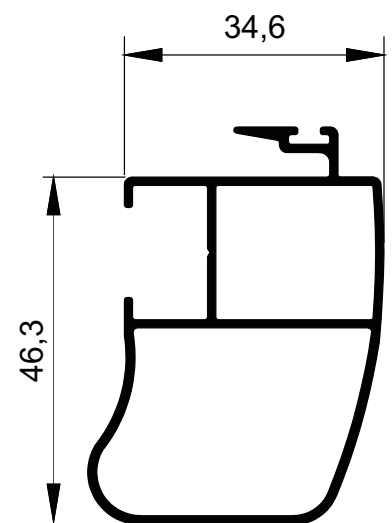

MG20-1090

0,662 kg/m

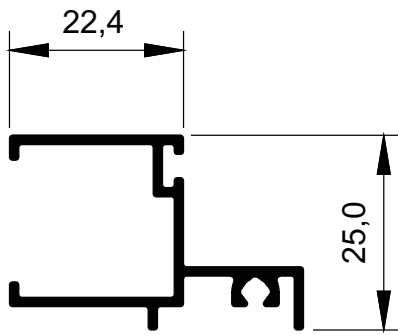

MG20-1610
0,408 kg/m

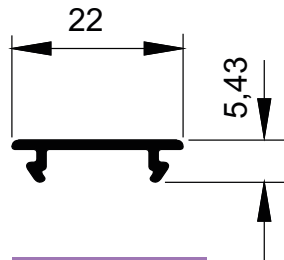

MG20-1630
0,106 kg/m

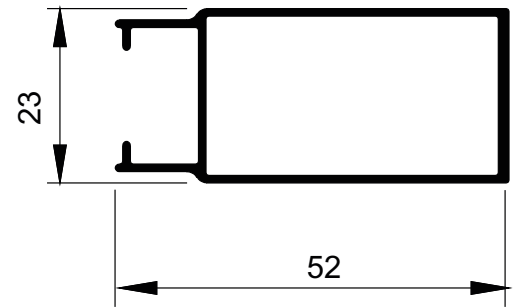

MG20-2210
0,435 kg/m

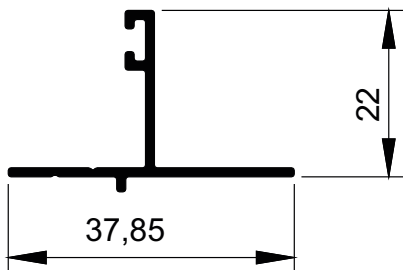

MG20-1615
0,222 kg/m

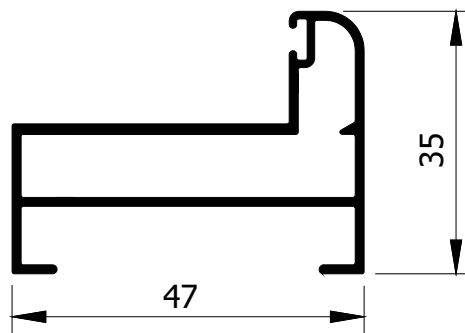

MG20-2230
0,574 kg/m

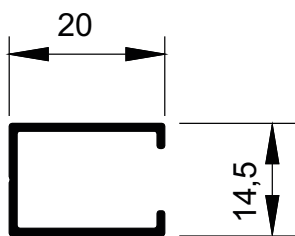

MG20-1625
0,154 kg/m

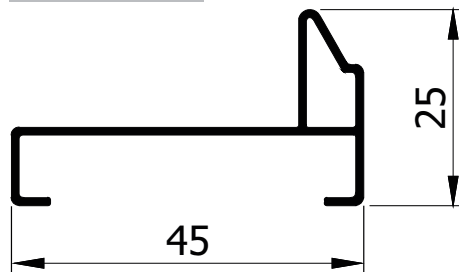

MG20-2250
0,280 kg/m

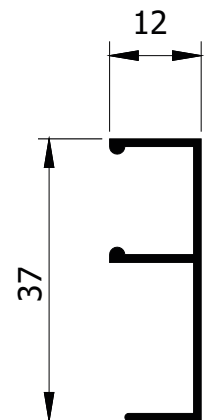

RA-347
0,197 kg/m

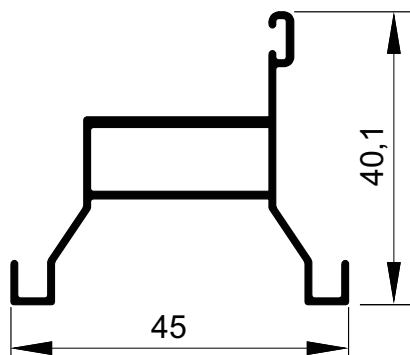

MG20-2200
0,412 kg/m

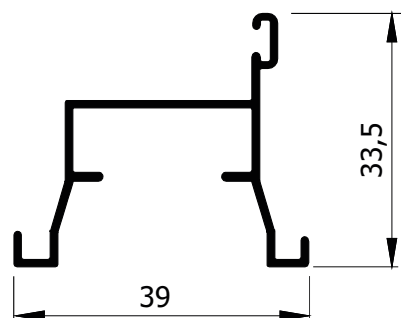

MG20-2240
0,300 kg/m

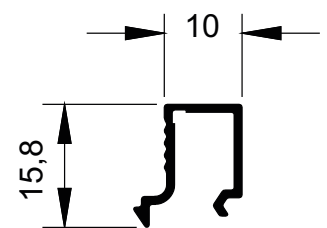

BG-035
0,119 kg/m

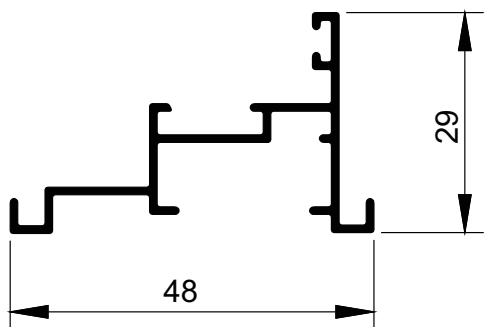

MG20-1605

0,337 kg/m

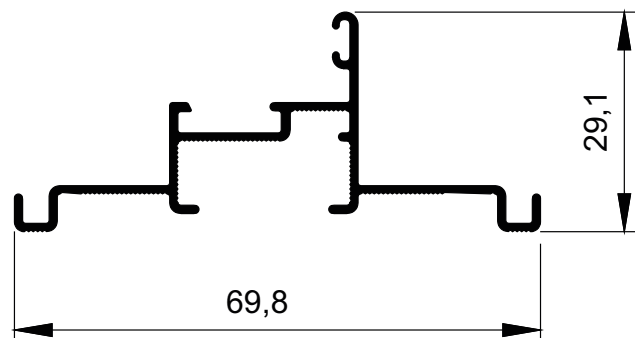

MG20-2220

0,440 kg/m

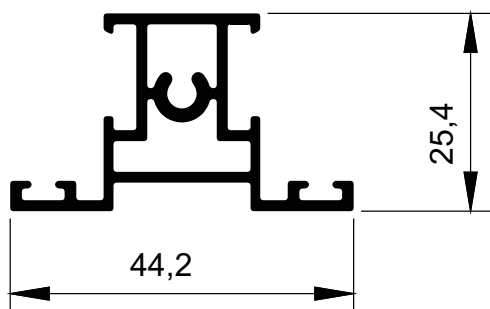

MM-376

0,590 kg/m

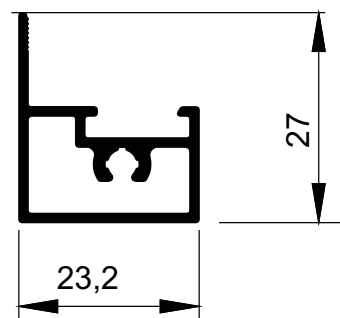

25-301

0,343 kg/m

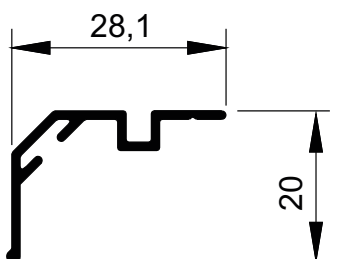

39-933

0,179 kg/m

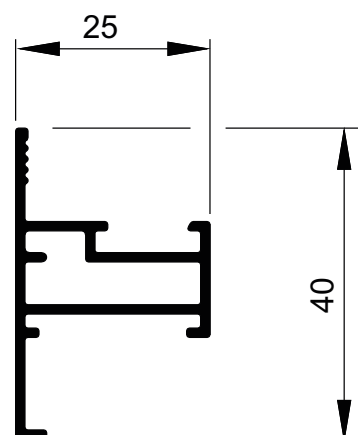

25-313

0,383 kg/m

TIPOLOGIAS POSSÍVEIS

JANELA DE CORRER 3 FOLHAS 1FX 2M SG
VENEZIANA

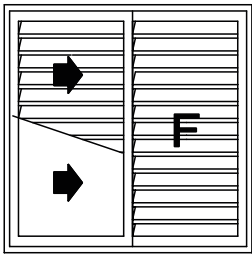

- MG20-1030
- MG20-1075
- MG20-1015
- MG16-370
- MG20-1035
- MG20-1081
- MG20-1070
- MG20-1045
- MG20-1010
- MG20-1040

JANELA DE CORRER 2 FOLHAS 1FX 1M SG
VITRÔ

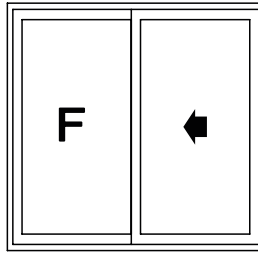

- MG20-1020
- MG20-1081
- MG20-1040
- MG20-1025
- MG20-1000
- MG20-1045
- MG20-1070
- MG20-1005

JANELA DE CORRER 2 FOLHAS 2M SG
VITRÔ

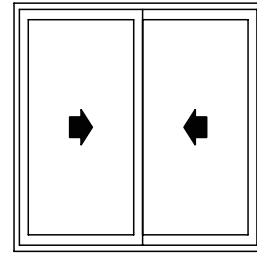

- MG20-1025
- MG20-1150
- MG20-1070
- MG20-1081
- MG20-1155
- MG20-1040

JANELA DE CORRER 3 FOLHAS 3M SG
VENEZIANA

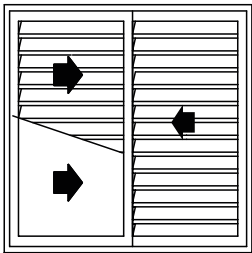

- MG20-1035
- MG20-1145
- MG20-1070
- MG20-1037
- MG20-1075
- MG16-370
- MG20-1140
- MG20-1081
- MG20-1040

JANELA DE CORRER 4 FOLHAS 2FX 2M SG
VITRÔ

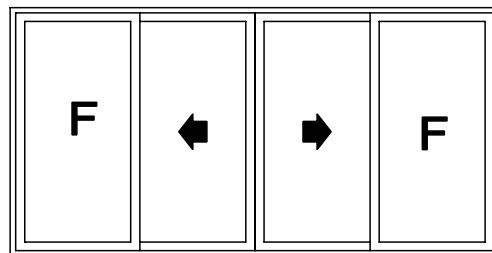

- MG20-1020
- MG20-1086
- MG20-1040
- MG20-1070
- MG20-1000
- MG20-1045
- MG20-1081
- MG20-1005

JANELA DE CORRER 6 FOLHAS 2FX 4M SG
VENEZIANA

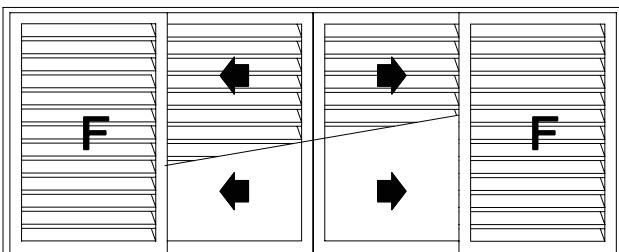

- MG20-1030
- MG20-1081
- MG20-1015
- MG20-1070
- MG20-1086
- MG20-1045
- MG16-370
- MG20-1075
- MG20-1010
- MG20-1040

JANELA DE CORRER 2 FOLHAS 1FX 1M CG
VITRÔ

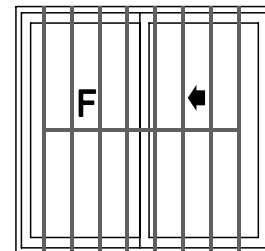

- MG20-1120
- MG20-1081
- MG20-1040
- MG16-355
- MG20-1037
- MG20-1110
- MG16-365
- MG20-1070
- MG20-1105
- MG16-350

JANELA DE CORRER 2 FOLHAS 2M CG
VITRÔ

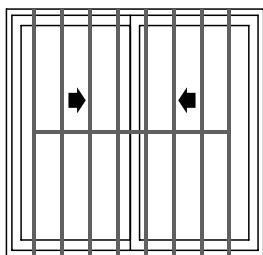

- MG20-1120
- MG20-1081
- MG20-1040
- MG16-355
- MG20-1037
- MG20-1110
- MG16-365
- MG20-1070
- MG20-1105
- MG16-350

JANELA DE CORRER 4 FOLHAS 2FX 2M CG
VITRÔ

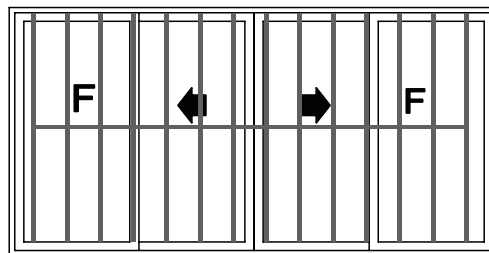

- MG20-1037
- MG20-1070
- MG20-1040
- MG16-355
- MG20-1081
- MG20-1086
- MG16-365
- MG16-350
- MG20-1110
- MG20-1105

JANELA DE CORRER 6 FOLHAS 2FX 4M CG
VENEZIANA

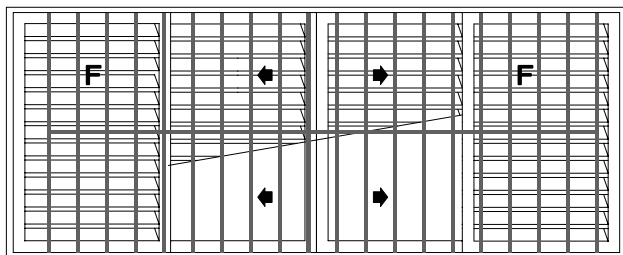

- MG20-1030
- MG20-1070
- MG20-1086
- MG20-1040
- MG20-1075
- MG20-1081
- MG20-1010
- MG20-1015
- MG20-1040
- MG20-1045
- MG16-370
- MG16-355
- MG16-365

JANELA DE CORRER 3 FOLHAS 1FX 2M CG
VENEZIANA

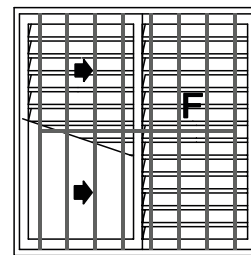

- MG20-1030
- MG20-1075
- MG20-1015
- MG20-1040
- MG20-1081
- MG20-1035
- MG20-1045
- MG20-1010
- MG20-1070
- MG16-365
- MG16-355
- MG16-370
- MG16-350

JANELA MAXIM-AR 1 FOLHA SG

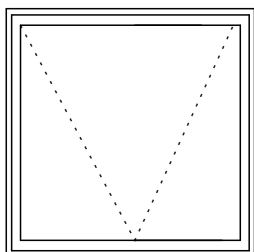

- MG20-1605
- 25-313
- BG-035
- 25-301
- 39-933

JANELA MAXIM-AR 2 FOLHAS + HORIZ SG

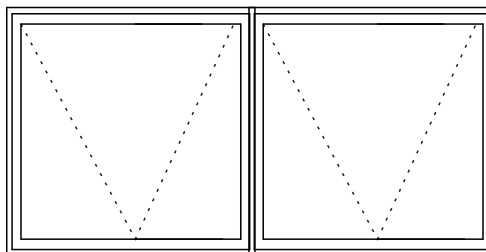

- MG20-1605
- 25-313
- BG-035
- 25-301
- 39-933
- MM-376

JANELA MAXIM-AR 1 FOLHA CG

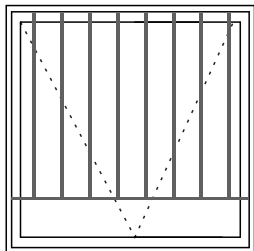

MG20-2220
25-313
BG-035
MG16-350
25-301
39-933
MG16-365
MG16-355

JANELA MAXIM-AR 2 FOLHAS + HORIZ CG

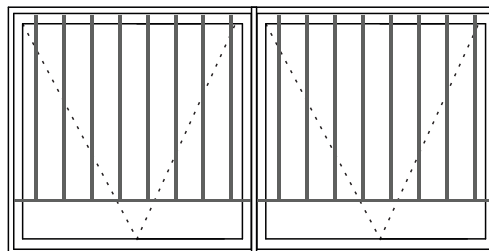

MG20-2220
25-313
BG-035
MG16-350
25-301
39-933
MG16-365
MG16-355
MM-376

JANELA MAXIM-AR 2 FOLHAS + VERT SG

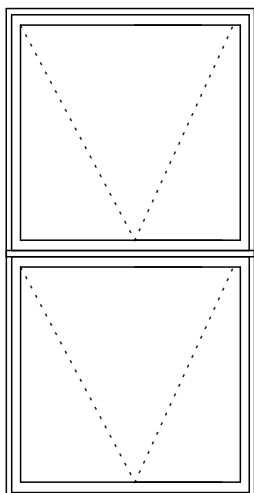

MG20-1605
25-313
BG-035
25-301
39-933
MM-376

JANELA MAXIM-AR 2 FOLHAS + VERT CG

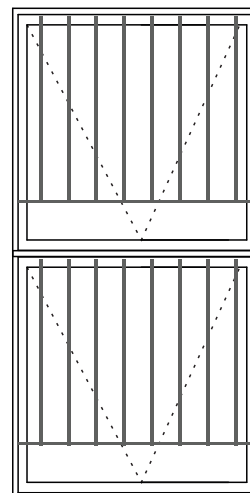

MG20-2220
25-313
BG-035
MG16-350
25-301
39-933
MG16-365
MG16-355
MM-376

PORTA DE CORRER 2 FOLHAS 1FX 1M

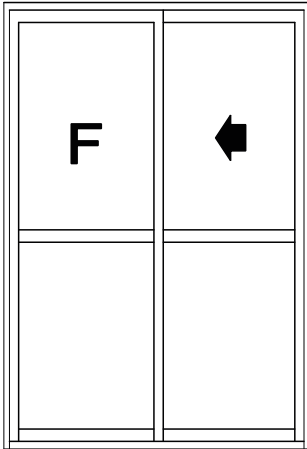

- MG20-1081
- MG20-1020
- MG20-1000
- MG20-1025
- MG20-1005
- MG20-1065
- MG20-1055
- MG20-1040
- MG20-1090
- MG20-1070
- MG20-1060
- MG20-1045

PORTA DE CORRER 4 FOLHAS 2FX 2M

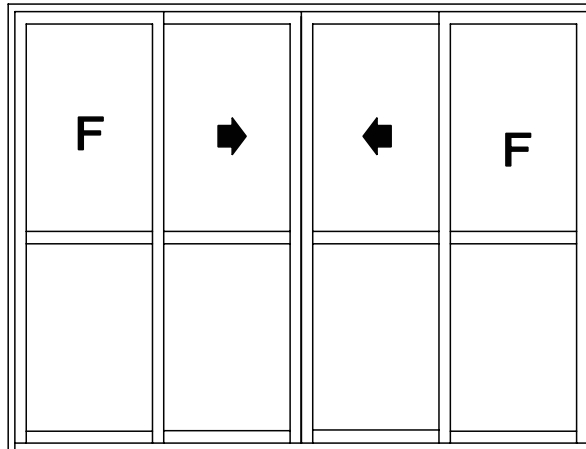

- MG20-1086
- MG20-1000
- MG20-1005
- MG20-1020
- MG20-1065
- MG20-1081
- MG20-1055
- MG20-1040
- MG20-1090
- MG20-1070
- MG20-1060
- MG20-1045

PORTA DE CORRER 2 FOLHAS 2M

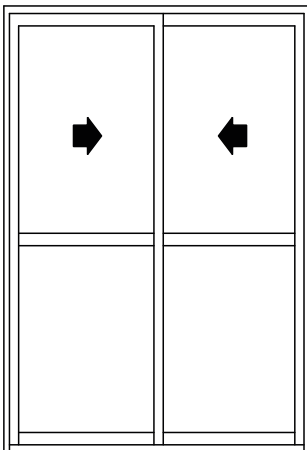

- MG20-1025
- MG20-1055
- MG20-1050
- MG20-1081
- MG20-1065
- MG20-1090
- MG20-1070
- MG20-1055
- MG20-1040

PORTA DE CORRER 3 FOLHAS 1FX 2M VENEZIANA

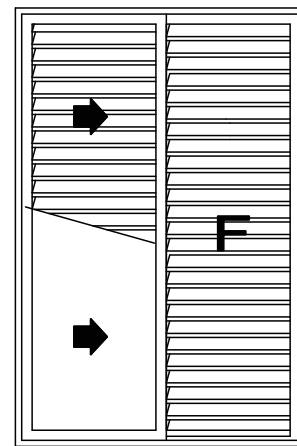

- MG20-1030
- MG20-1035
- MG20-1015
- MG20-1081
- MG20-1075
- MG20-1010
- MG20-1065
- MG16-370
- MG20-1055
- MG20-1040
- MG20-1090
- MG20-1070
- MG20-1060
- MG20-1045

PORTA DE CORRER 3 FOLHAS 3M VENEZIANA

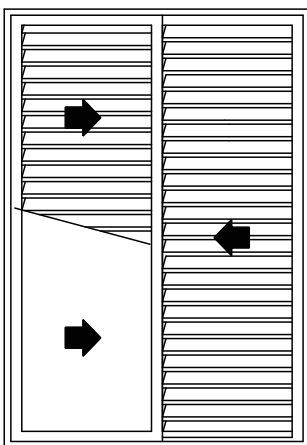

- MG20-1035
- MG20-1037
- MG20-1140
- MG20-1065
- MG20-1145
- MG20-1075
- MG20-1081
- MG16-370
- MG20-1055
- MG20-1040
- MG20-1090
- MG20-1070

PORTA DE CORRER 6 FOLHAS 2FX 4M VENEZIANA

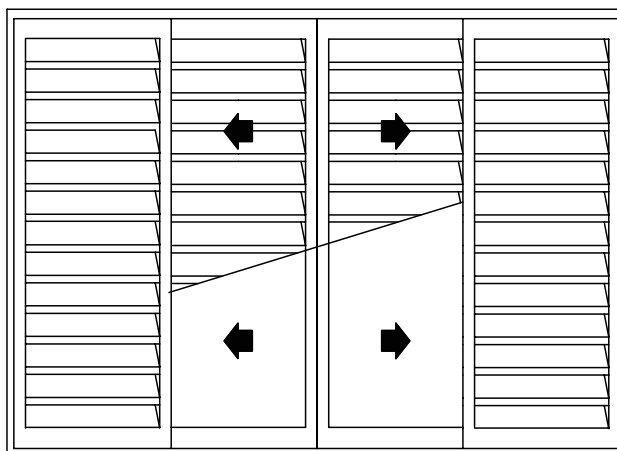

- MG20-1030
- MG20-1081
- MG20-1075
- MG20-1065
- MG20-1010
- MG20-1015
- MG20-1086
- MG16-370
- MG20-1055
- MG20-1040
- MG20-1090
- MG20-1070
- MG20-1060
- MG20-1045

PORTA DE GIRO 1 FOLHA 1/2 VZ 1/2 BA

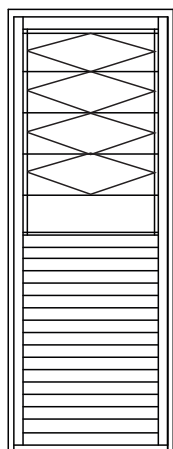

MG20-2210
MG20-1045
MG16-325
MG16-330
MG16-345
MG16-370
MG20-1065
MG16-340
MG20-2200
MG20-2240

PORTA DE GIRO 1 FOLHA 1/2 VZ 1/2 VI

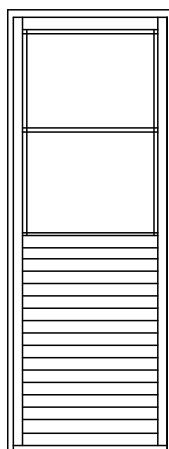

MG20-2210
MG20-1045
MG20-1620
MG16-370
MG20-1065
MG20-2200
MG20-2240

PORTA DE GIRO 1 FOLHA
1/2 VZ 1/2 POSTIGO CG

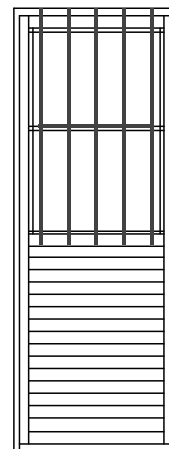

MG20-2200
MG20-2240
MG20-2210
MG20-1065
MG16-1610
MG20-1045
MG20-355
MG20-1615
MG16-370
MG20-1625
MG20-1620
MG20-1630
MG16-365
MG16-350

PORTA DE GIRO 1 FOLHA LAMINADA

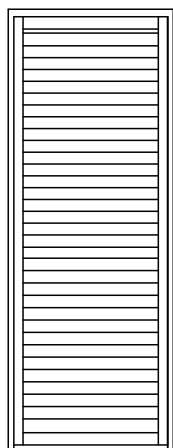

MG20-2210
MG20-1045
MG20-1065
MG16-370
MG20-2200
MG20-2240

PORTA DE GIRO 1 FOLHA LAMBRIL

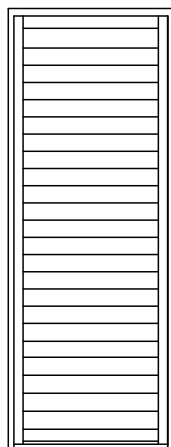

MG20-2210
MG20-1045
MG20-1065
79-025
MG20-2200
MG20-2240

PORTA DE GIRO 1 FOLHA MADEIRA

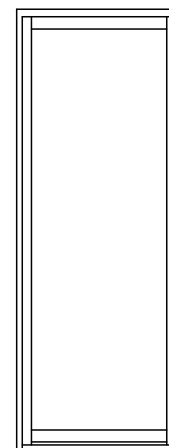

MG20-2230
MG20-2250
RA-347

Lined area for notes.



asa
aluminio



asa

alumínio

19 3227-1000 | Rua da Cerâmica, 100 São José
19 3727-2000 | 13051-156 Campinas - SP

Nossa história, **nosso nome**, nossa identidade. **Asa sempre!**

